



POOL AND HOT TUB PERMIT REQUIREMENTS

Contents

1. Introduction
2. Additional Approvals & Design Considerations
3. Sample Drawings
4. Building Permit Application Checklist
5. Pool Permit Application Form
6. Agent Authorization Form

Introduction

The following guide has been developed to assist homeowners in obtaining a building permit for a swimming pool or hot tub. Any pool capable of holding a minimum depth of 30" of water requires a building permit. Once an application is received it will be reviewed by staff for sufficiency of completion. If the application is not accompanied by the plans, specifications, information, and documents as outlined in this information pamphlet, the applicant will be notified of the outstanding information required. Incomplete applications will be placed on hold until all the required information is received. Complete applications will be reviewed within 10 business days.

Definitions

Above ground pool means: An outdoor swimming pool of which no part is below ground level.

On ground pool means: An outdoor swimming pool that is partially installed in the ground and partially installed above ground.

In ground pool means: An outdoor swimming pool that is built entirely into the ground as a permanent fixture.

Lot Grading

As per the Township of North Dumfries site alteration by-law (#2612-18), "no person shall alter, or permit or cause any alteration within the Township without a permit." Due to the Township's site alteration by-law, as well as many properties within our built up areas and subdivisions in the Township having a lot grading plan deposited with the Township, an updated grading plan is required where inground and on ground pools are being installed on properties within settlement areas, less than 1 acre in size or with an existing grading plan. If the Township has an existing lot grading plan on file, we will provide a copy to the owner of the property within 5 business days of a request.

An updated grading plan needs to be completed and stamped by a licensed professional such as an Ontario Land Surveyor, P. Eng., CET or Landscape Architect,.

Zoning By-law Requirements

All pool fence locations & installation shall conform to the Township of North Dumfries most recent pool fence by-law. Please view the following link for greater context and additional information:
<https://www.northdumfries.ca/en/township-services/resources/Documents/Swimming-Pools-1620-96.pdf>

General requirements as per By-law 1620-96

- A swimming pool is a permitted structure in association with a permitted residential use.
- The swimming pool and pool accessories, including walkways, shall be a minimum of 1m to any rear or interior side lot line.
- The swimming pool shall not be located closer to the front lot line than the dwelling house.
- A building or accessory structure or part thereof, may be used to enclose a pool.
- The walls of an above ground pool may act as its own required enclosure, provided it meets all other requirements of a pool fence.

Fencing Requirements as per By-law 1620-96

- Height: A pool fence shall be not less than 1.5m (5'-0")
- Gates: All gates must be self-closing, self-latching and lockable. The gate must only be operable from the pool side and must be locked when not in use.
- Location: The pool fence may occur on the property line but in no case closer than 1.5m (5'-0") to the pool or any climbable structure, including another fence.
- Construction: The pool fence shall be of vertically boarded wood construction, chain link construction or of other materials and construction of an equivalent degree of safety. Chain link fence shall be not greater than 39mm (1 ½") diamond mesh. All horizontal members shall be a min of 1.1m apart and located on the pool side of the fence

Permit Fees

Pool building permit fees for 2024 are flat fee of \$205 which applies to all pools. An additional \$205 fee will be added to any pool that is installed without a permit.

NOTE: A Building Inspector may visit the property prior to issuing the pool permit. This helps to identify any potential concerns prior to the pool installation such as overhead wires or lot grading.

Additional Approvals & Design Considerations

Decks

If you also plan to build a deck, please refer to the Townships website for deck permit requirements. A separate building permit application with drawings is required for a deck.

Pool houses and Sheds

If you also plan to build a pool house or shed which is greater than 10m² (108 sq.ft.), please refer to the Townships website for accessory structure permit requirements. A separate building permit application and drawings is required for an accessory structure.

Grand River Conservation Authority

Your property may fall under the jurisdiction of the Grand River Conservation Authority; therefore, a separate permit would be required from the GRCA and must accompany the building permit application. Please contact John Brum, at jbrum@grandriver.ca for additional information.

Source water Protection

Your property may fall under the jurisdiction of the Source Protection Plan for Waterloo Region; therefore, a separate permit would be required from the Region and must accompany the building permit application. Please contact

RiskManagementOfficial@regionofwaterloo.ca

Or visit <https://taps.regionofwaterloo.ca/Html5Viewer/index.html?viewer=taps/>

Septic Systems

Structures shall be a minimum of 1.5m (5'-0") from a septic tank and 5m (16'-4") from a septic bed. For further information, please visit our website or email building@northdumfries.ca.

Underground Utility Locates

Contact Ontario One Call to locate underground utilities before you dig. To request a free locate

call 1-800-400-2255 or visit www.on1call.com.

Electrical Safety Authority

All electrical work requires a permit from the Electrical Safety Authority (ESA). A copy of the ESA final certificate is required in order to finalize your building permit.

Contact the ESA at 1-877-372-7233 to obtain a permit.

Road Occupancy Permit/Damage Deposit

Where a subject property fronts on a Township Road an road occupancy permit/damage deposit may be required for your pool construction to ensure no damage is done to Township infrastructure, such as boulevard, sidewalks, driveway ramp and curb & gutter as a result of heavy trucks and equipment required to install some pools.

<https://www.northdumfries.ca/en/township-services/resources/Documents/Road-Occupancy-Permit-Application.pdf>

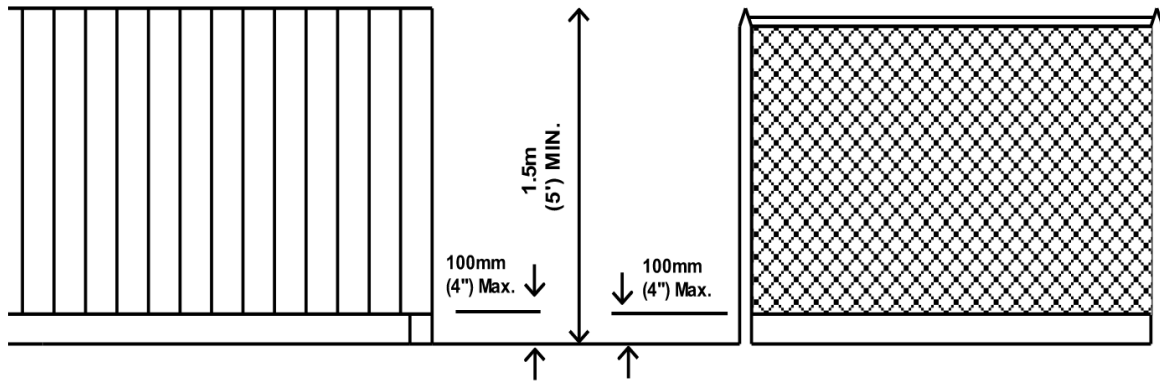

VERTICAL BOARD
NO OPEN SPACE

CHAIN LINK
38mm (1.5") MESH MAX.

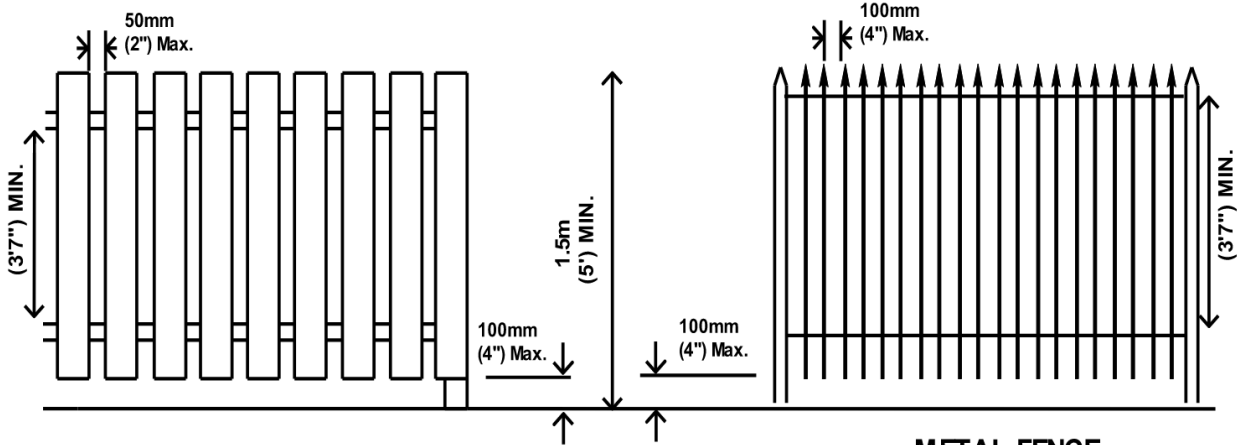

VERTICAL BOARD

METAL FENCE

Sample Drawings

TOWNSHIP OF NORTH DUMFRIES EXAMPLE POOL / POOL FENCE SITE PLAN

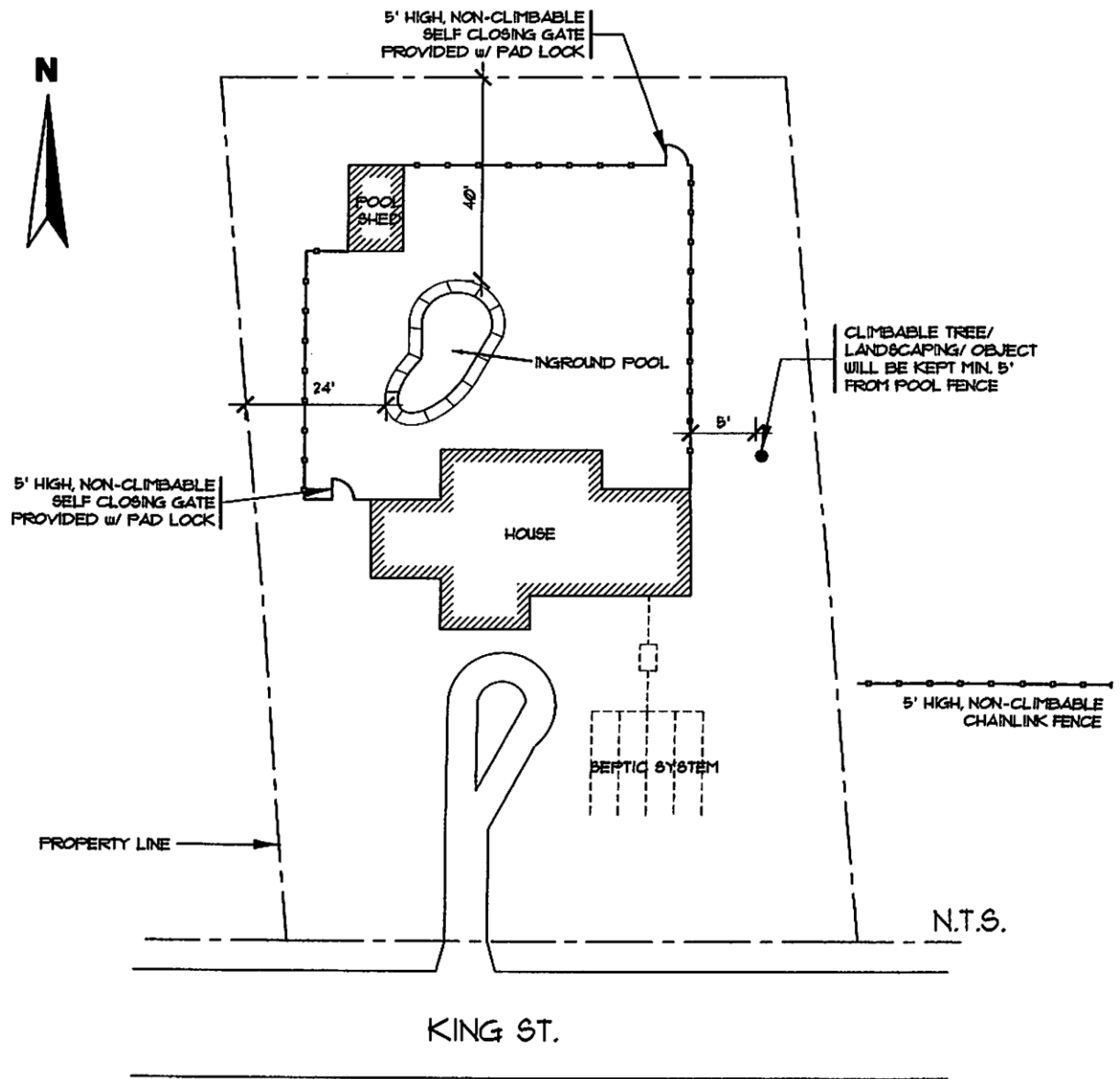

Note: If the fence is a perimeter fence, show climbable objects on neighboring properties.

TOWNSHIP OF NORTH DUMFRIES EXAMPLE ABOVE GROUND POOL SITE PLAN

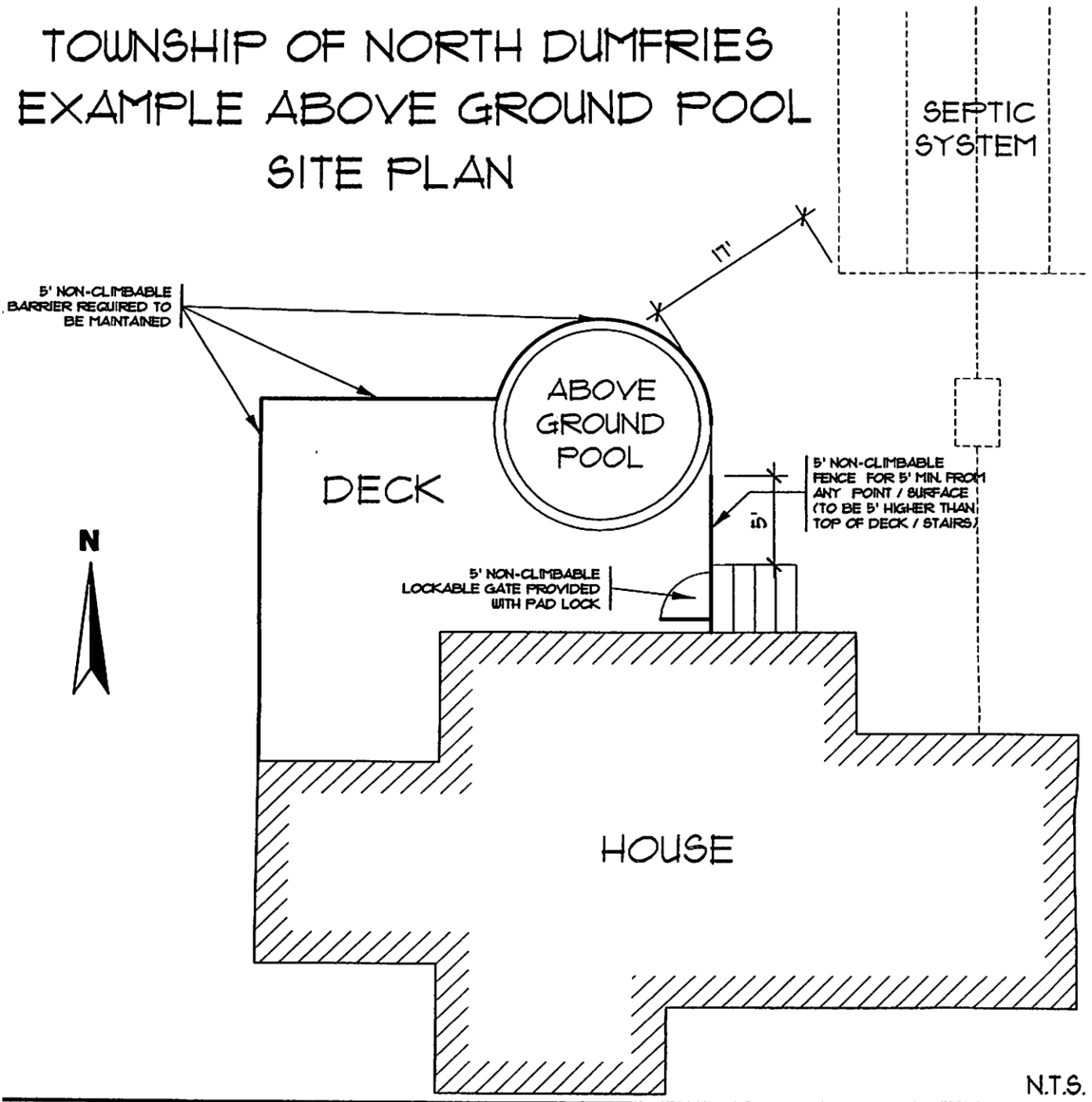

Note: This drawing is missing property lines, property lines must be on Site Plans.

Building Permit Application Checklist (Pools and Hot tubs)

Items required for a complete building permit application submission:

SITE PLAN

✓	Check when included
	Property address
	Dimensions and area of the property
	Location of proposed pool and distances to property lines, fences, pool pump, and any existing structures
	Location and square footage of all existing structures on the property
	Location and size of the septic tank and tile bed and distance from proposed pool
	Location of any easements and overhead wires on the property
	Location, height, and type (wood, chain link, iron) of fences and gates (gates must be self-closing and lockable)
	Site plans may be hand drawn but must be clear and drawn to scale
	All site plan details maybe shown on grading plan

DESIGN PLANS

✓	Check when included
	Grading Plan (required for On-ground and In-ground pools, in urban settlement areas, on properties less than 1 acre in size or properties with an existing lot grading plan)
	Manufacturer's specifications of any prefabricated guards, fences, handrails etc.

REQUIRED FORMS

✓	Check when included
	Completed Pool Permit Application form.
	Agent Authorization form (required if the property owner is not submitting the application)
	Approvals from other agencies as required (GRCA, Source water protection, MTO, etc..)
	Road Occupancy Permit/damage deposit

Note: Please hold all payments until the plans review has been completed and a voucher for payment has been emailed to the permit applicant.